

# SOLES SOLEADOS

PARA DÍAS NUBLADOS

Alumnos y alumnas de 1° de Ed. Primaria  
Junio 2020

# DISEÑAR UN SOL BRUNO MUNARI

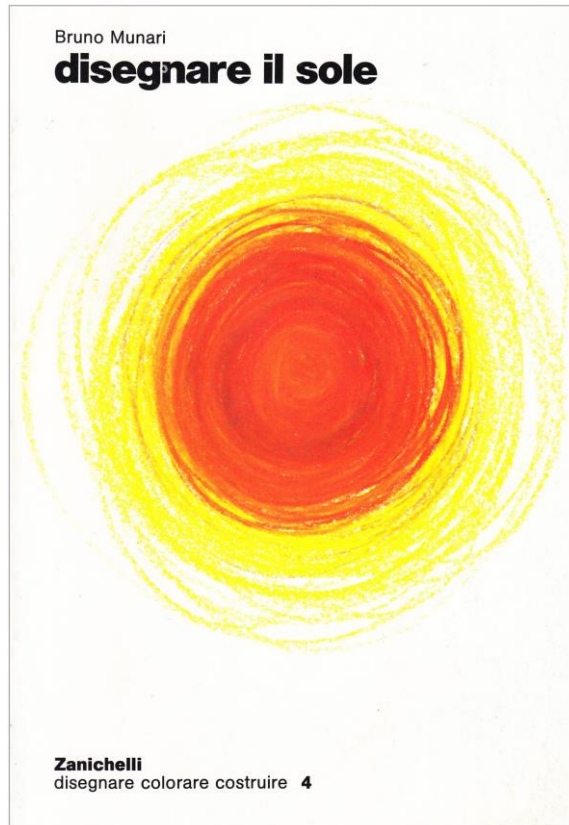

Los alumnos de 1º de Primaria han realizado una propuesta del área de arte basada en el libro de **Bruno Munari** “Disegnare il sole”.

El objetivo de esta publicación es el de ayudar a los alumnos a relacionarse con el lenguaje visual, de forma creativa.

Una forma de impulsar a los niños a ser atentos observadores del mundo que los rodea y de salir de los estereotipos del dibujo infantil.

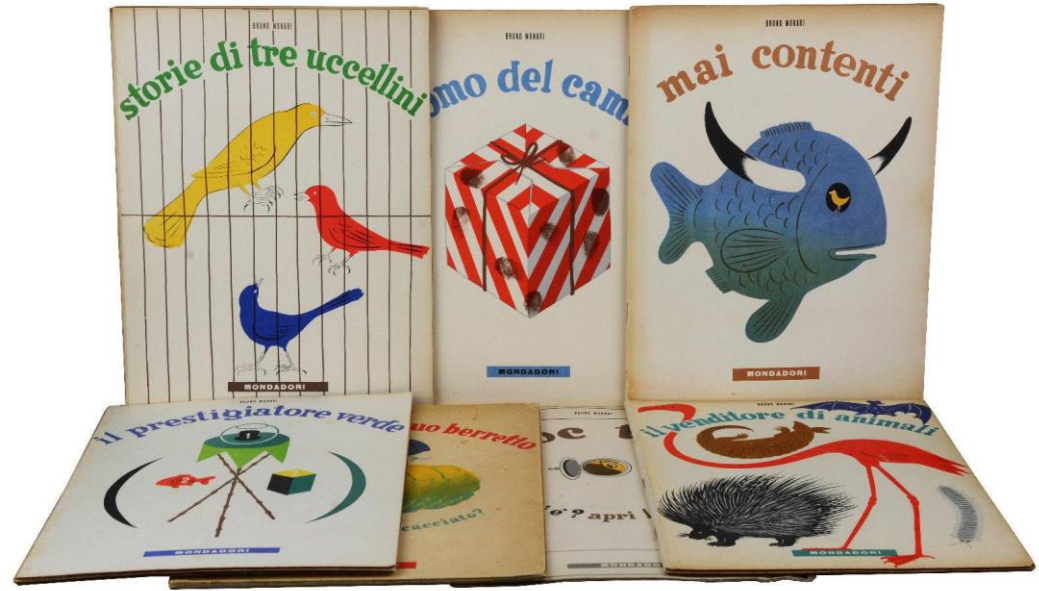

Bruno Munari fue un artista, escritor y diseñador italiano. Muchos conocemos algunos de sus cuentos: Caperucita roja, amarilla, azul y blanca; Bruno Munari's ABC, La tarta voladora, TOC-TOC, etc.

Pero además de escribir cuentos infantiles, Munari escribió muchísimos libros para adultos sobre qué significa ser diseñador, cómo diseñar objetos, técnicas para diseñar...

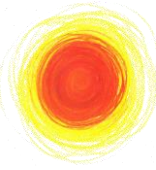

# SOLES CON ALFABETO GRÁFICO

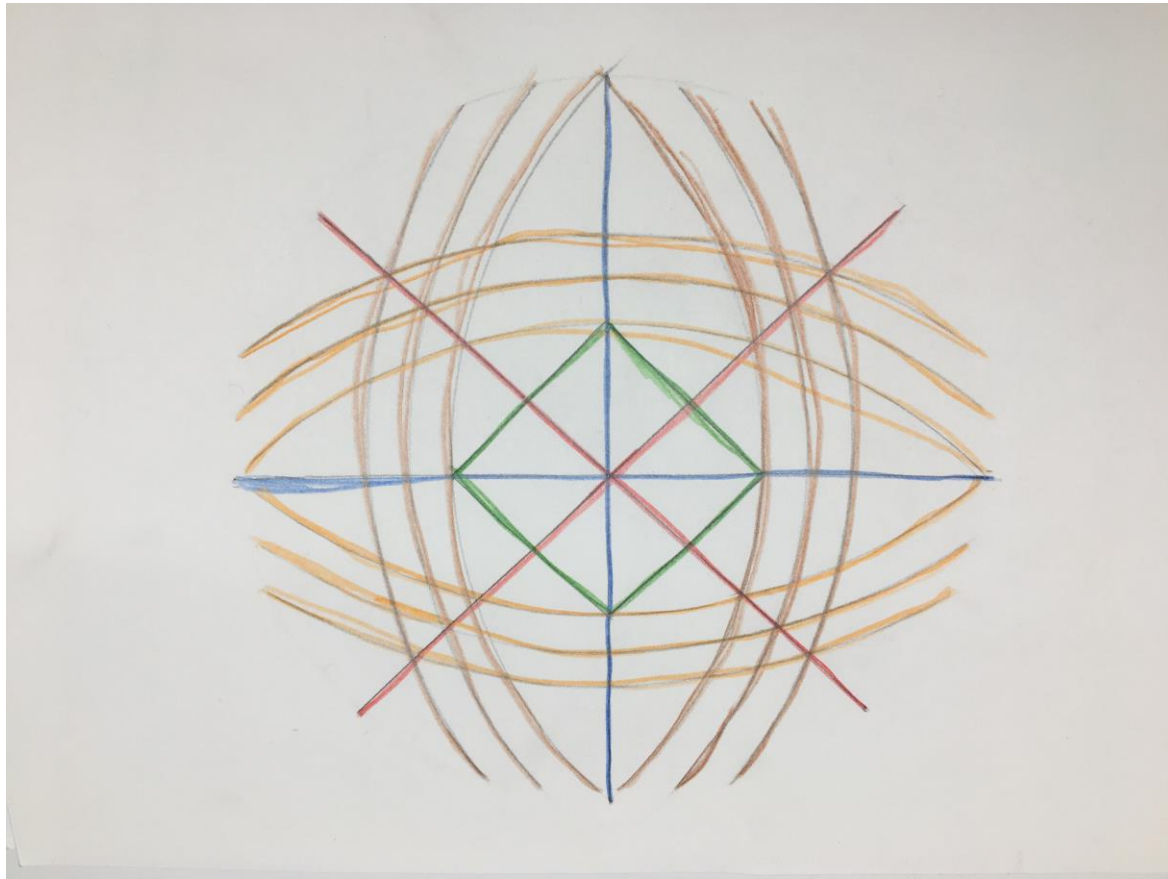

Rodrigo G.

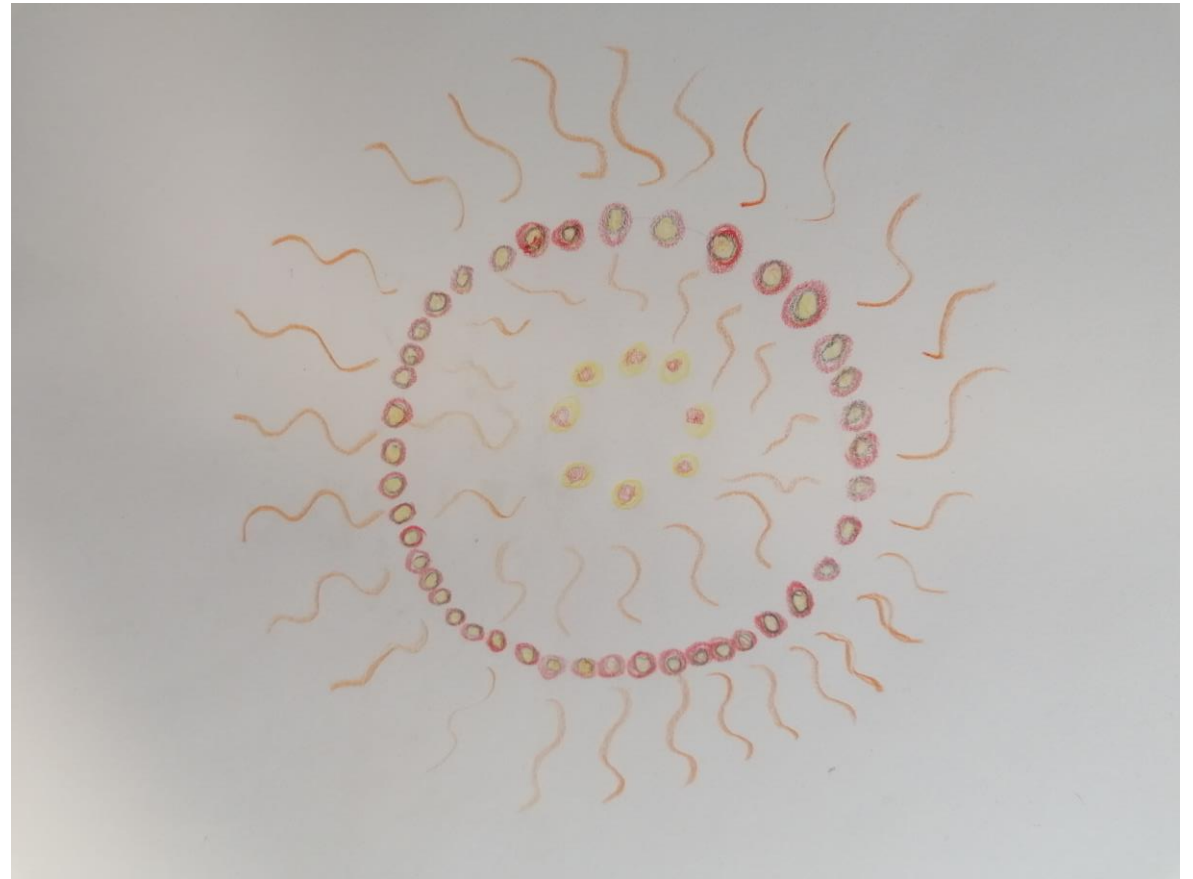

Eva S.

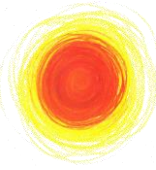

# SOLES CON ALFABETO GRÁFICO



Mateo C.



Alba P.

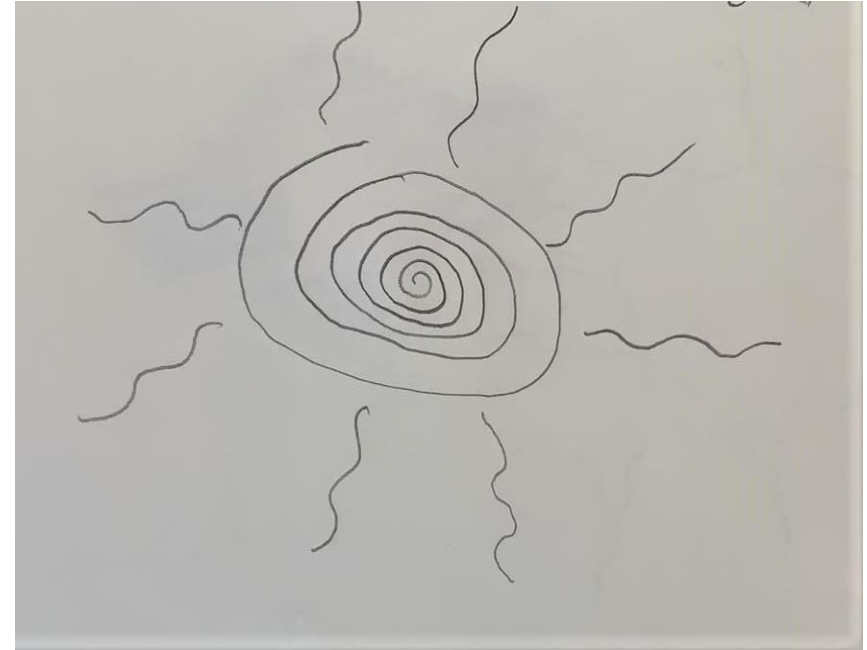

Martina M.

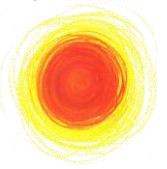

# SOLES GEOMÉTRICOS

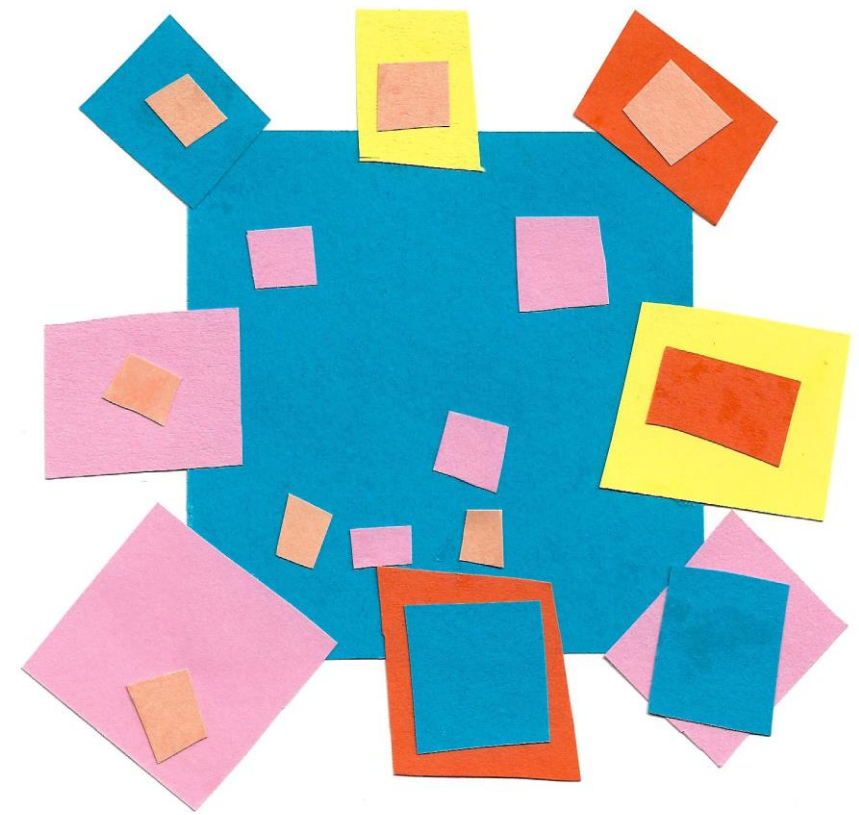

Aitana P.

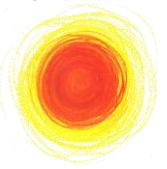

# SOLES GEOMÉTRICOS



Carlos C.



Leo C.



Eva S.

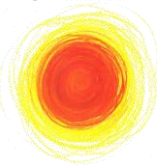

# SOLES GEOMÉTRICOS



Victoria C.

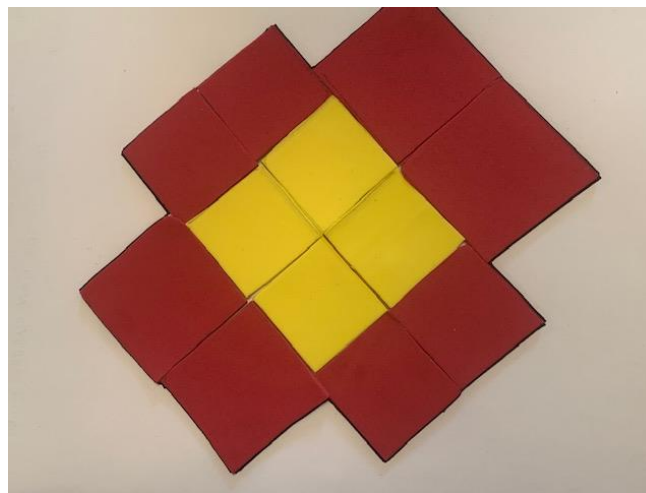

Victoria B.



Marc B.



Mireia V.



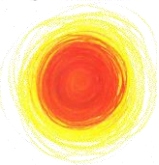

# SOLES GEOMÉTRICOS



Carmen M. R.



Carlos C.

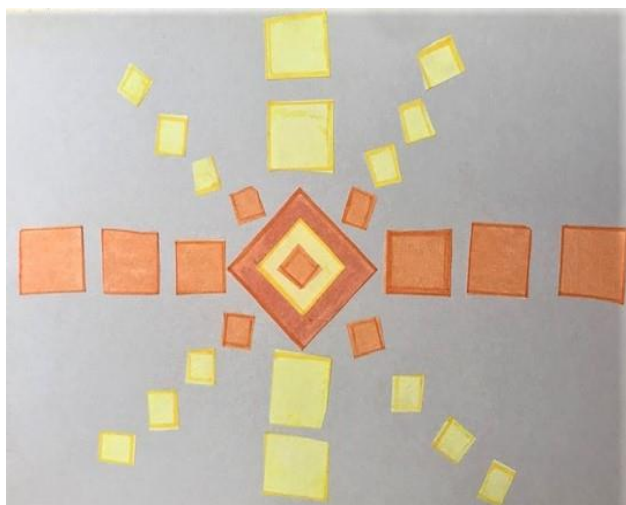

Mireia V.

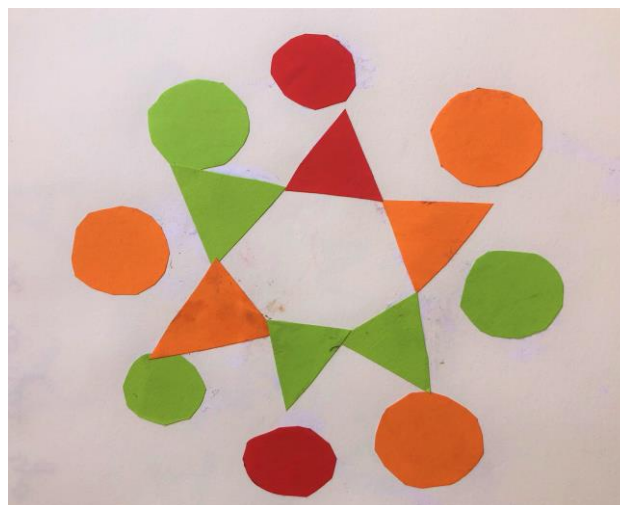

Alba P.

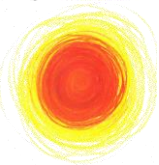

# SOLES GEOMÉTRICOS

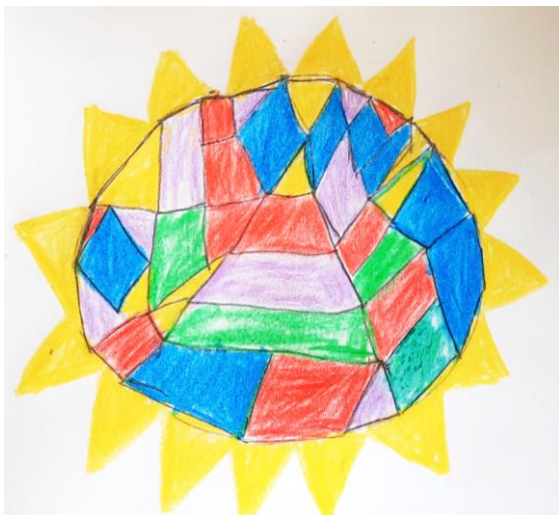

Noah A.

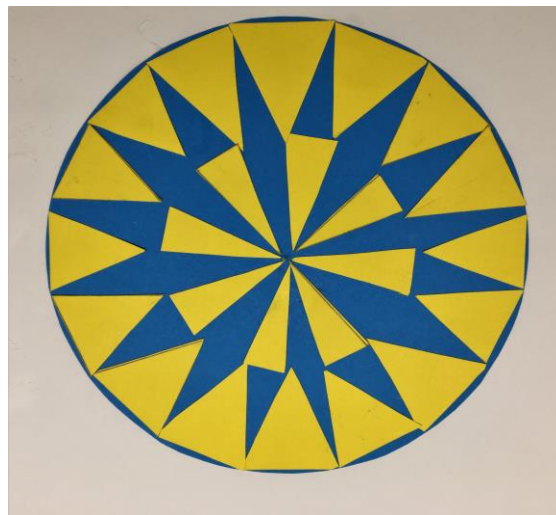

Rodrigo G.



Diego C.



Diego C.

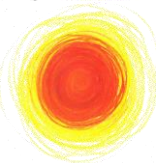

# SOLES EN LA HISTORIA DEL ARTE



Rodrigo G.

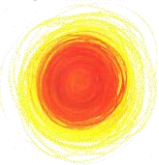

# SOLES EN LA HISTORIA DEL ARTE

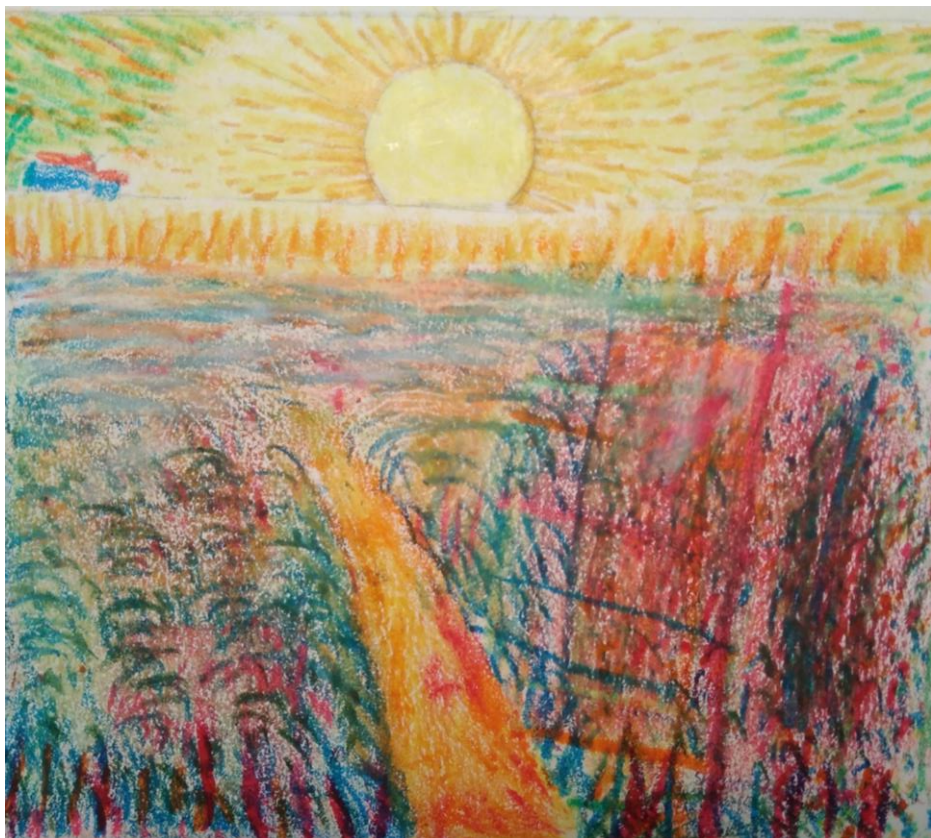

Carmen M. R.

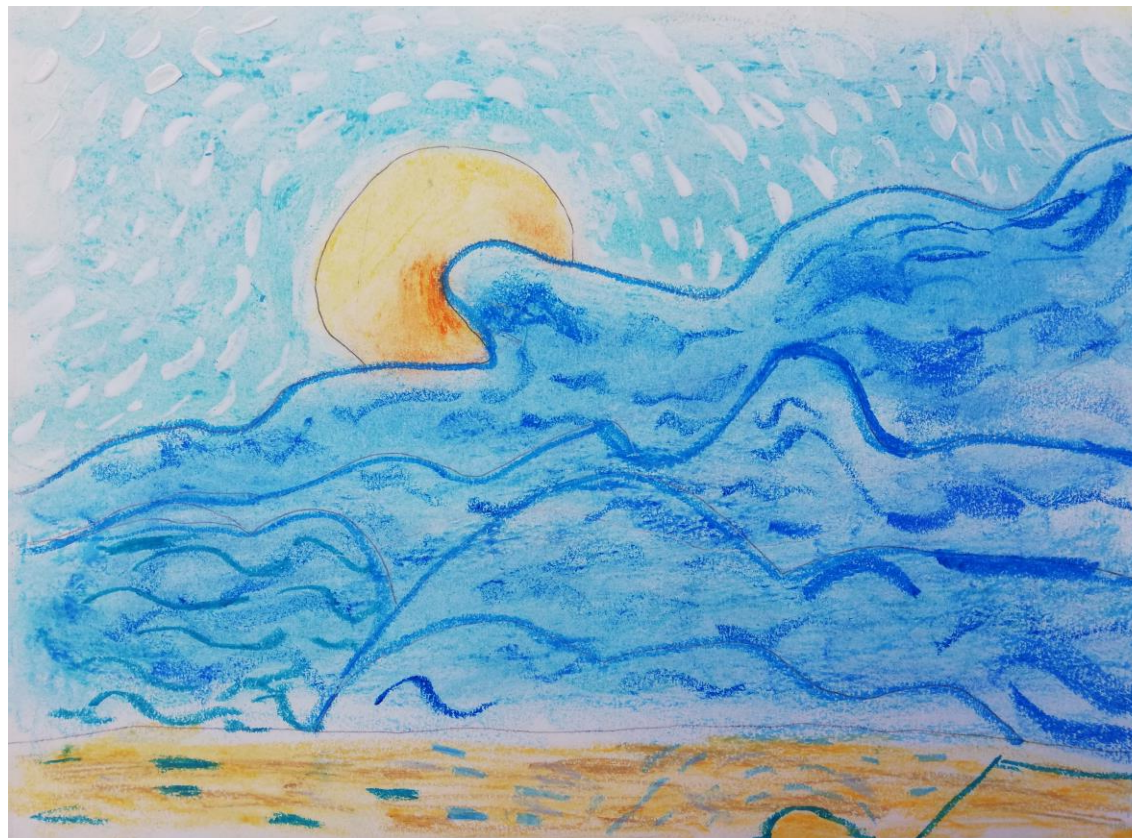

Diego C.

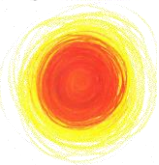

# SOLES EN LA HISTORIA DEL ARTE



Carlos C.



Lis O.

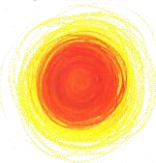

# SOLES EN LA HISTORIA DEL ARTE



Miguel V.



Leo C.

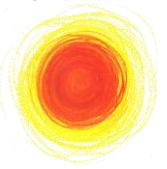

# SOLES CON LETRAS

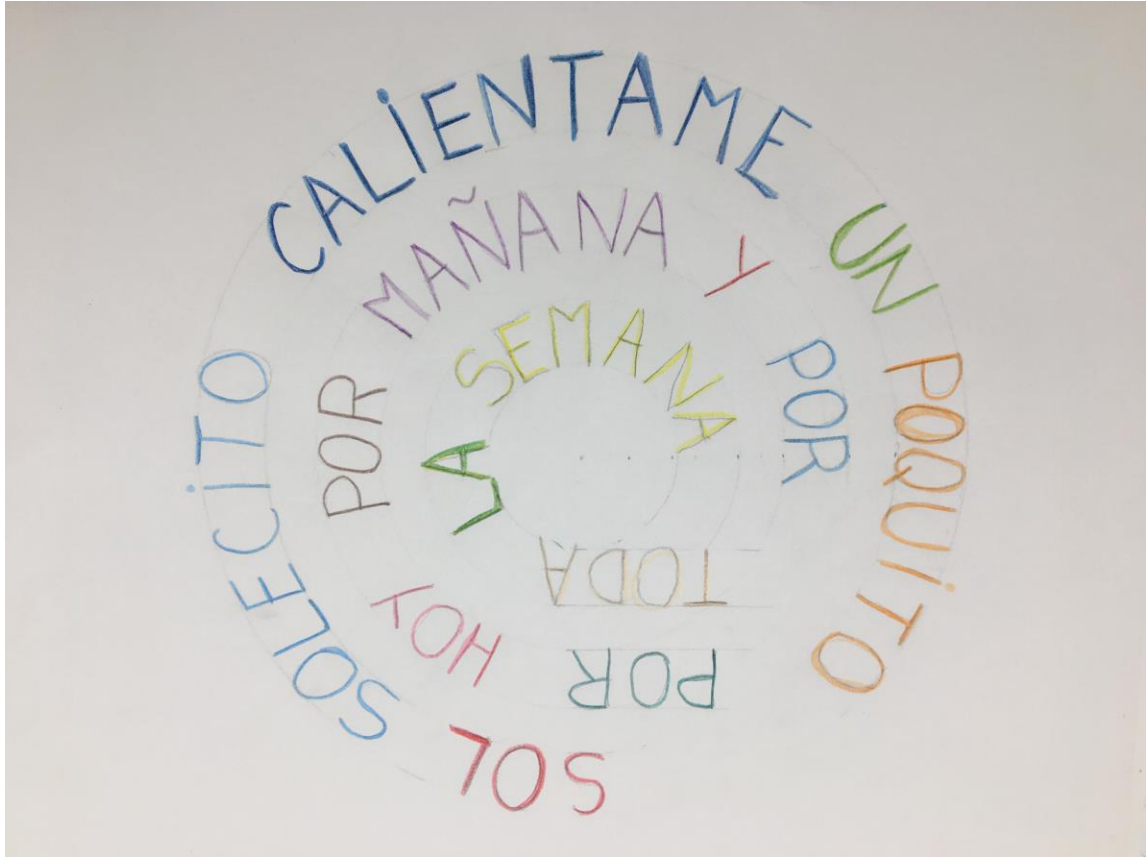

Rodrigo G.



Darío R.

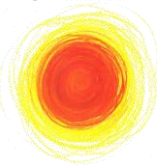

# SOLES CON LETRAS

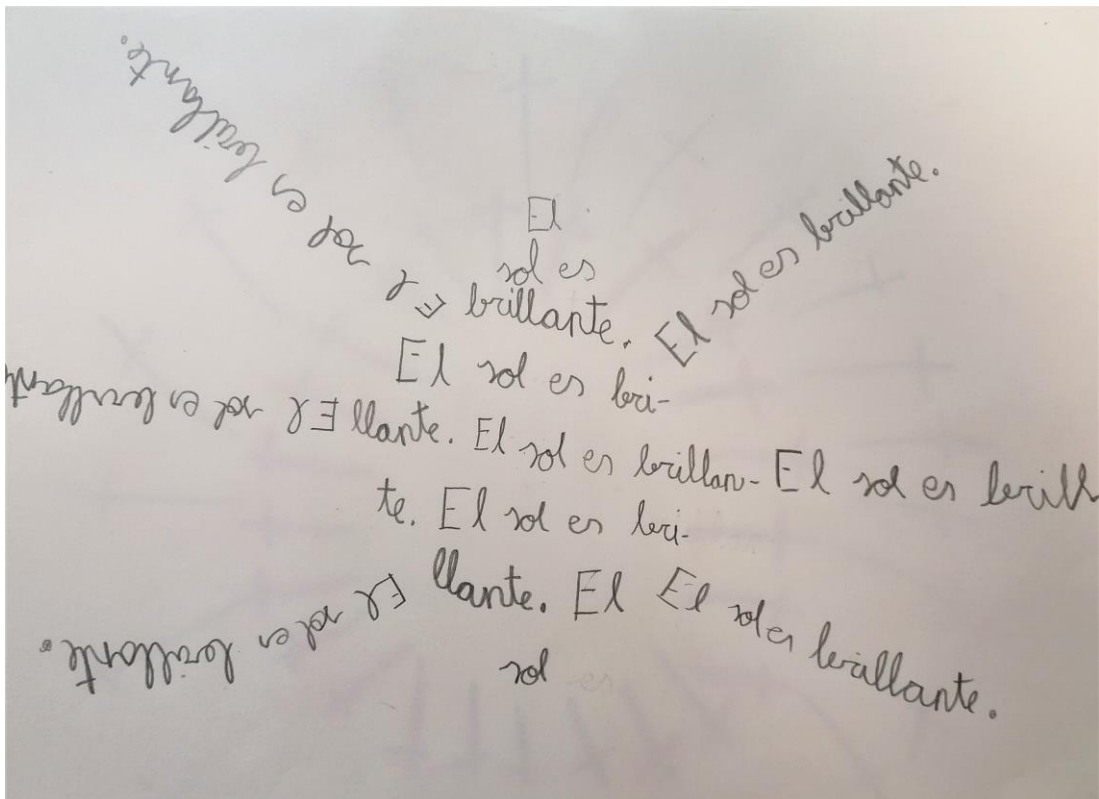

Eva S.



Lis O.



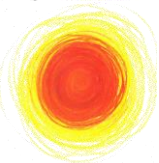

# SOLES CON LETRAS

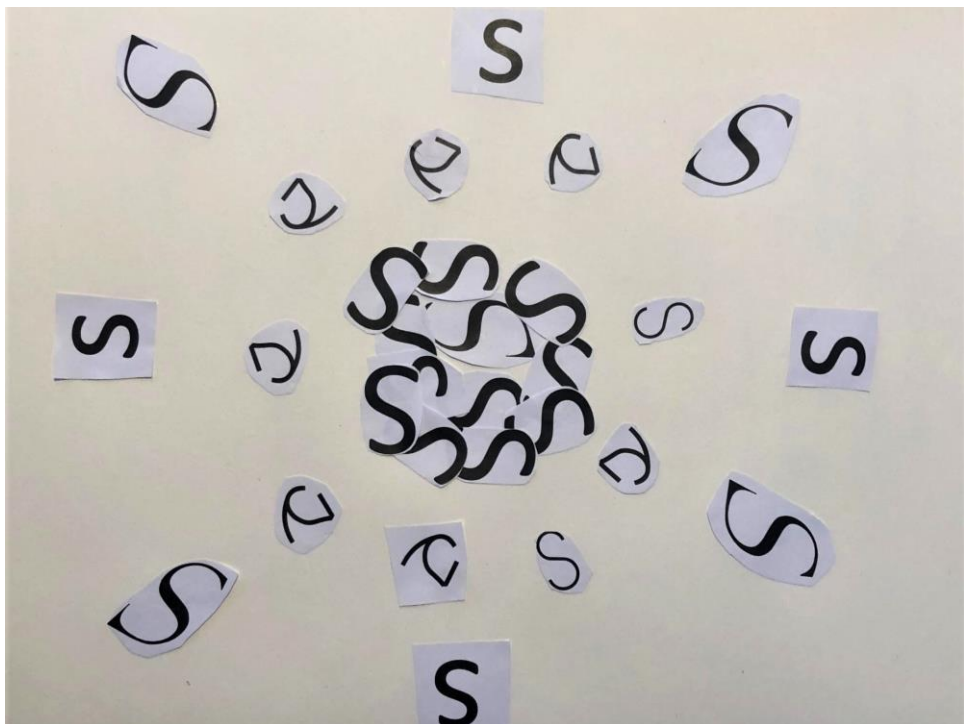

Rafael S.

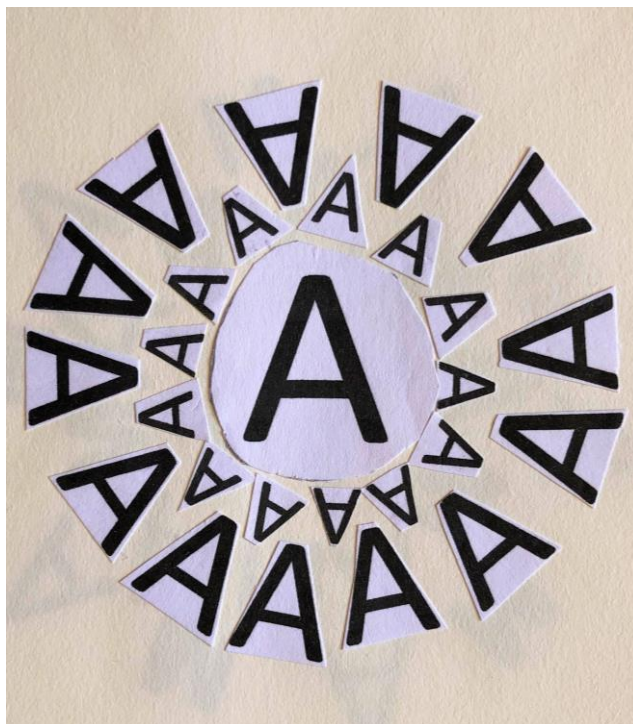

Miriam B.



Leo C.

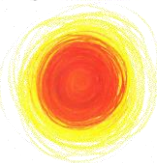

# SOLES CON LETRAS

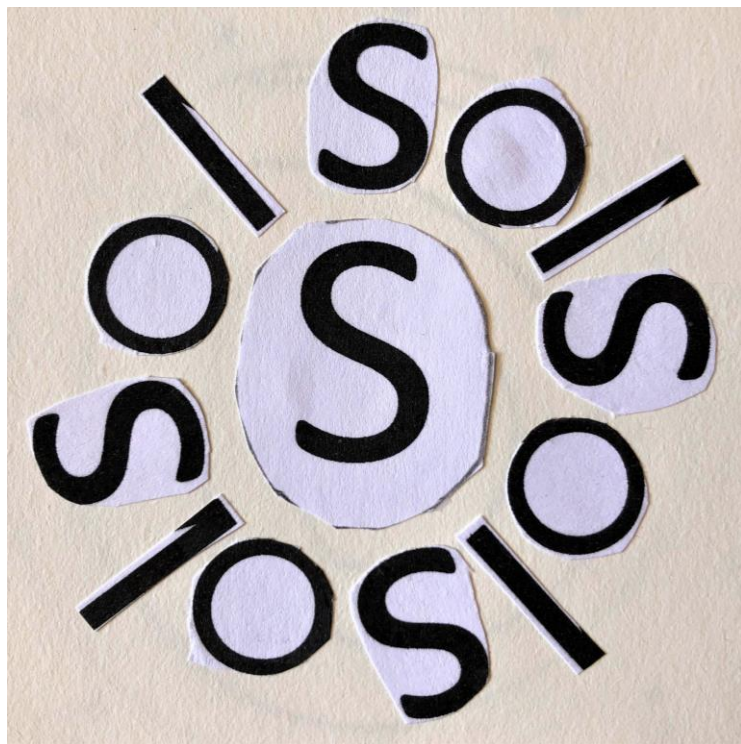

Miriam B.

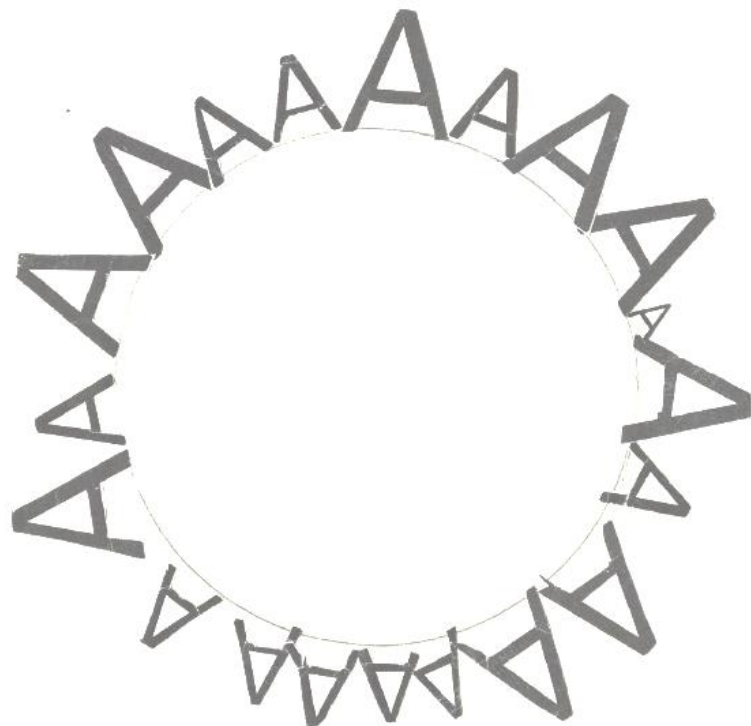

Marola S.

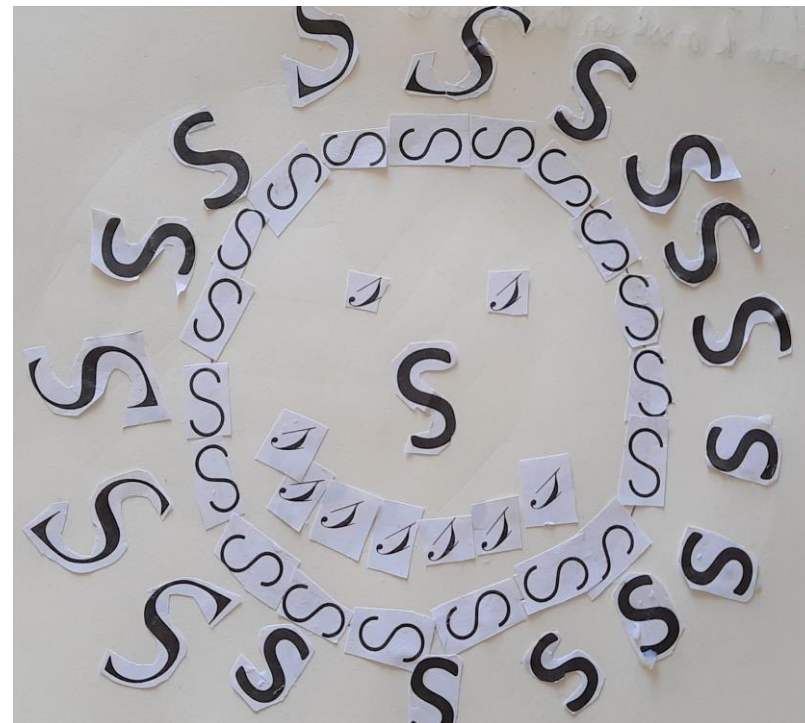

Noah A.

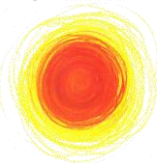

# SOLES CON LETRAS

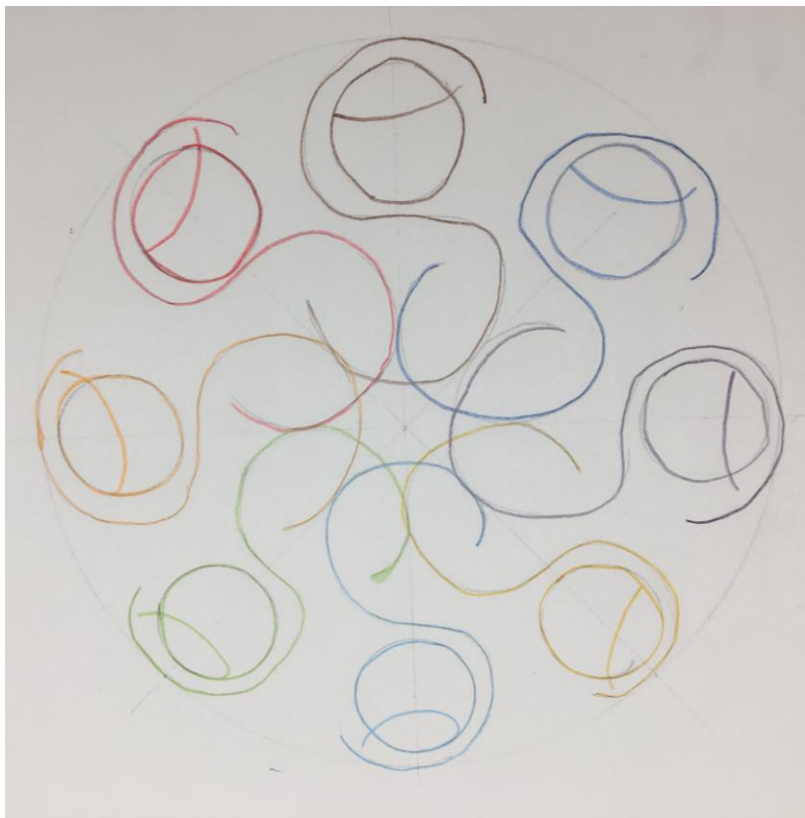

Rodrigo G.

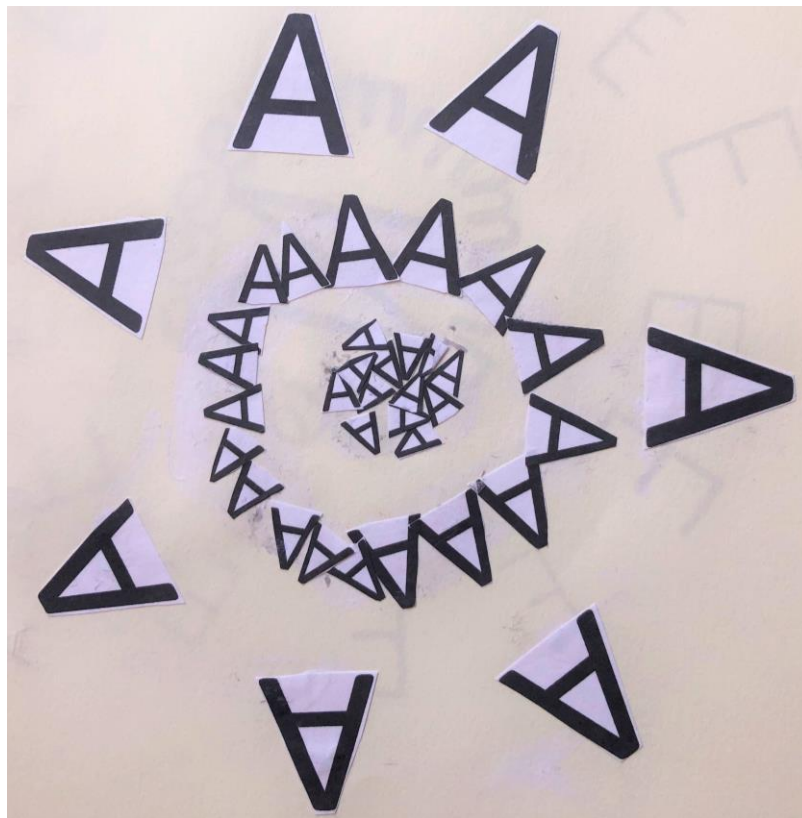

Alba P.

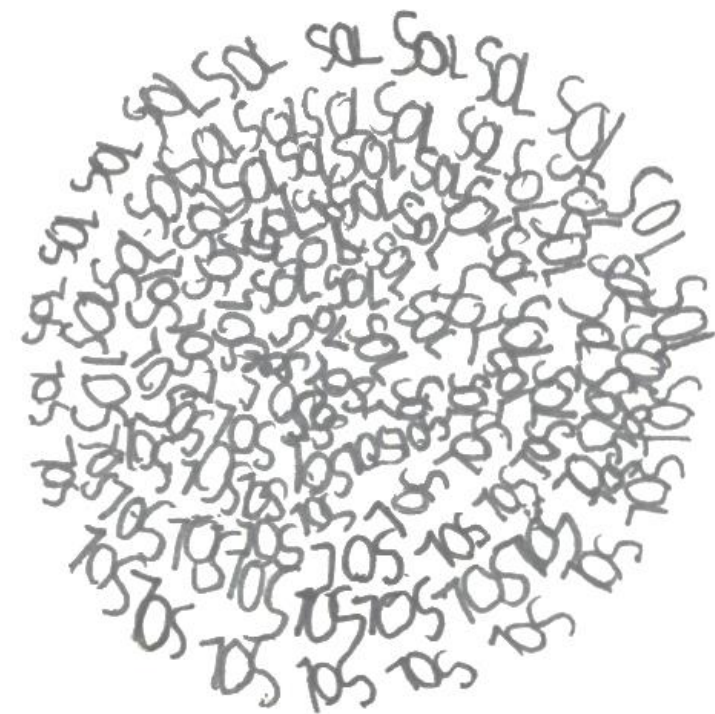

Marola S.

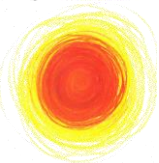

# SOLES CON LÍNEAS

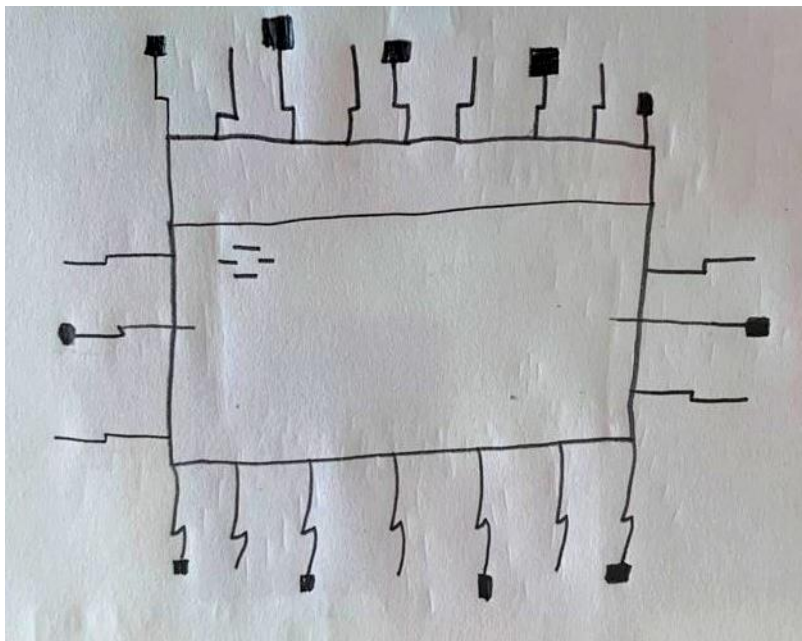

Carlos C.

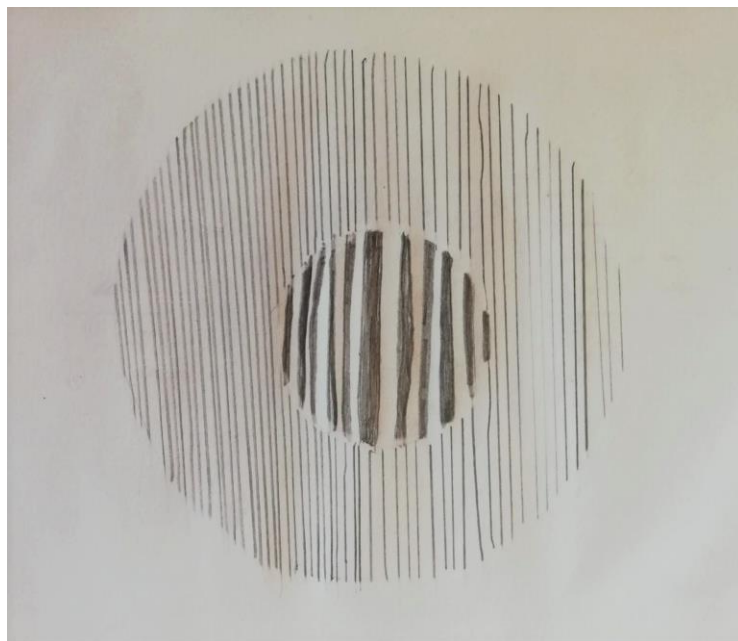

Diego C.



Leo C.

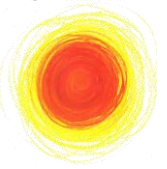

# SOLES CON LÍNEAS

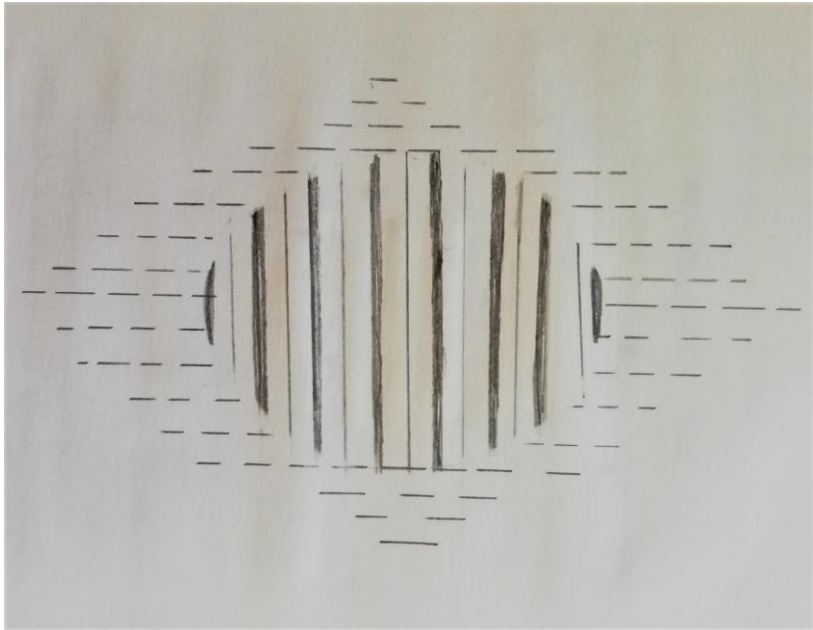

Diego C.

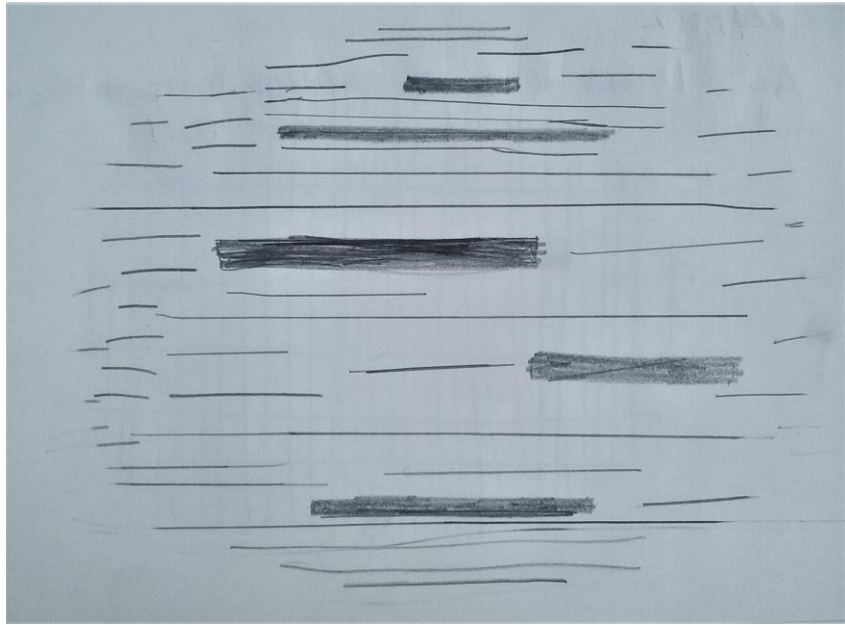

Lis O.

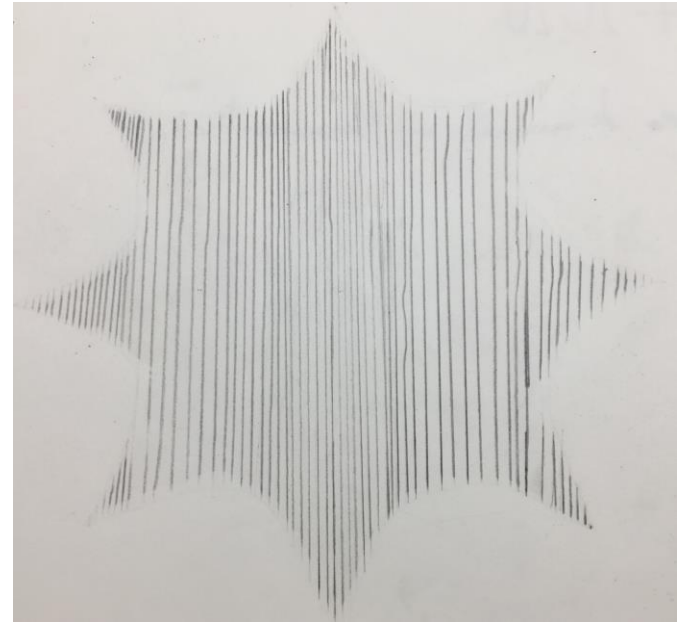

Rodrigo G.



# SOLES CON LÍNEAS

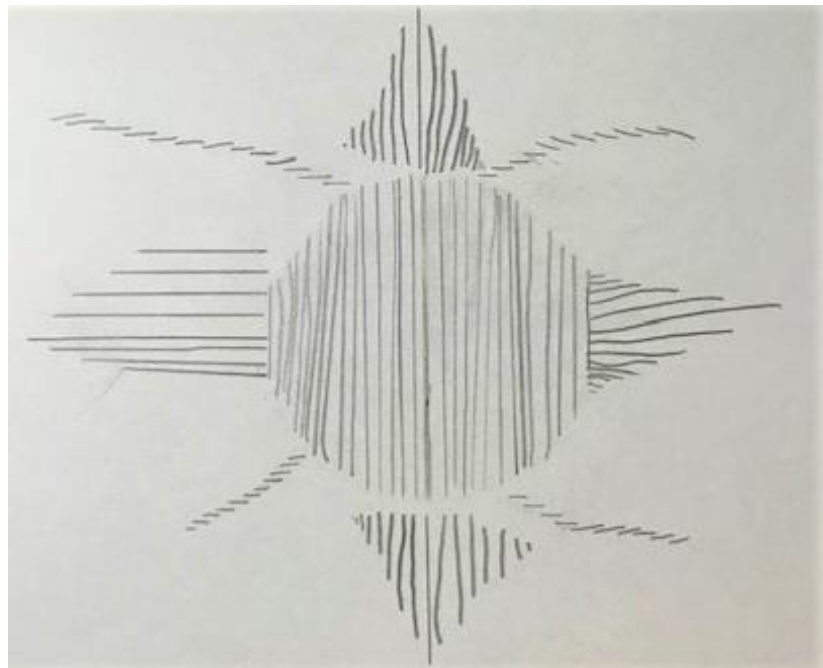

Mireia V.

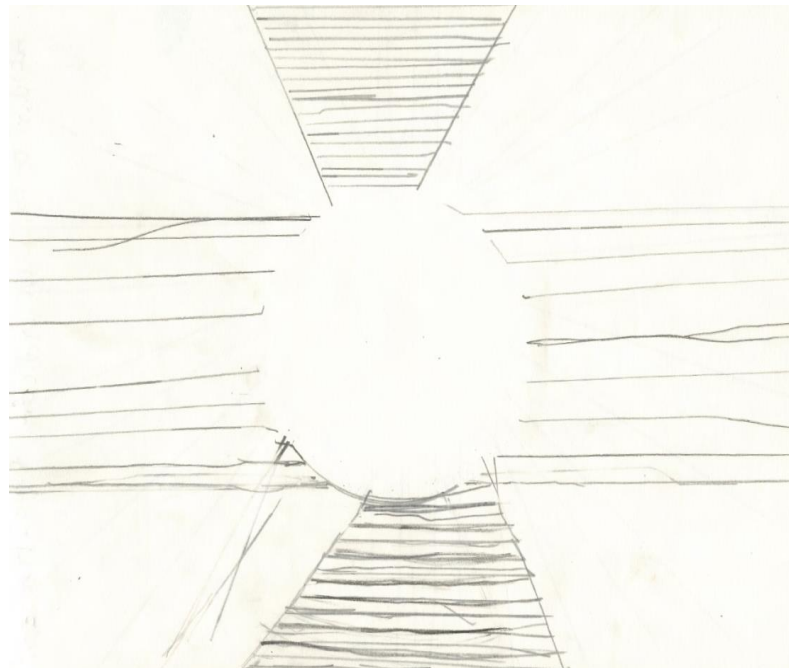

Marola S.

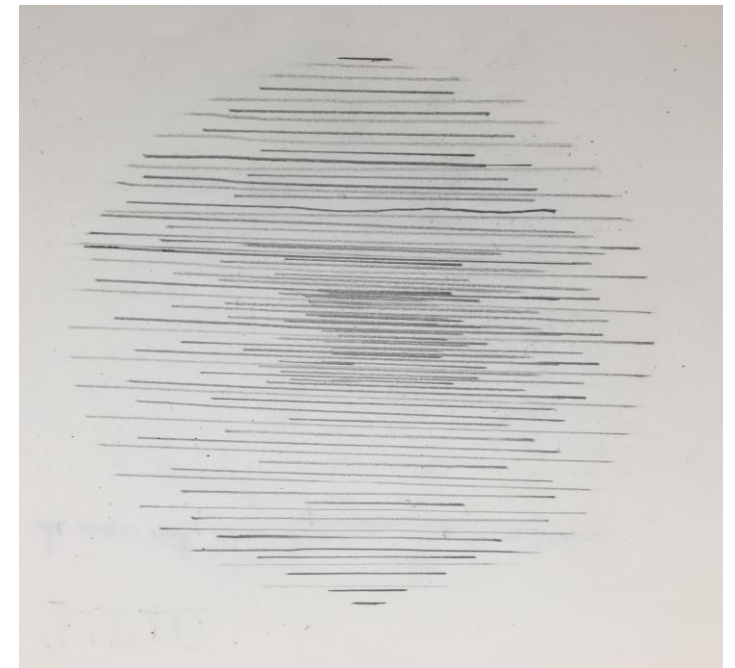

Rodrigo G.

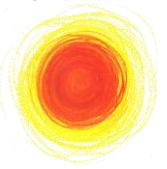

# SOLES CON LÍNEAS



Naia Q.

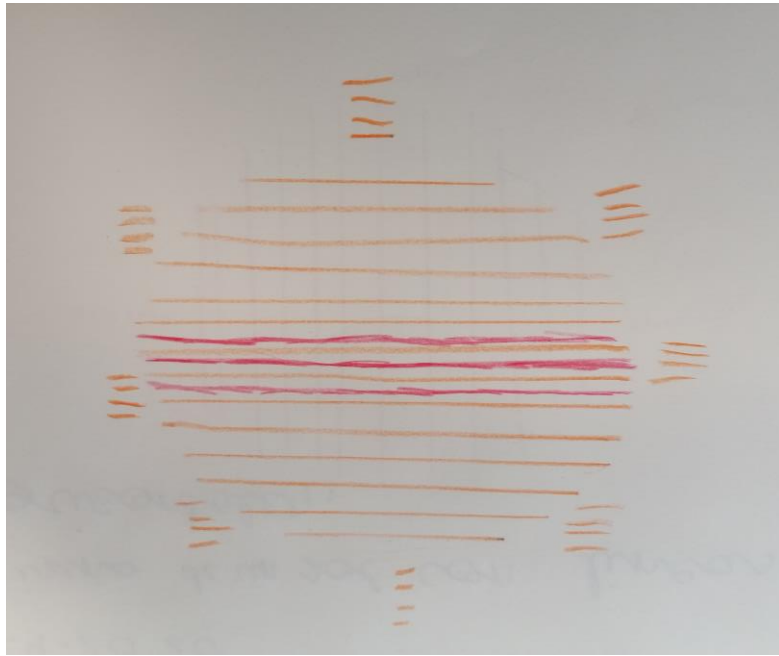

Eva S.



Miguel V.

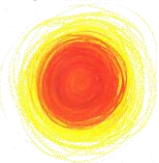

# SOLES OBJETOS



Miguel V.



Álvaro C.



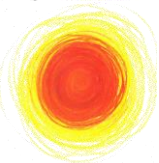

# SOLES OBJETOS

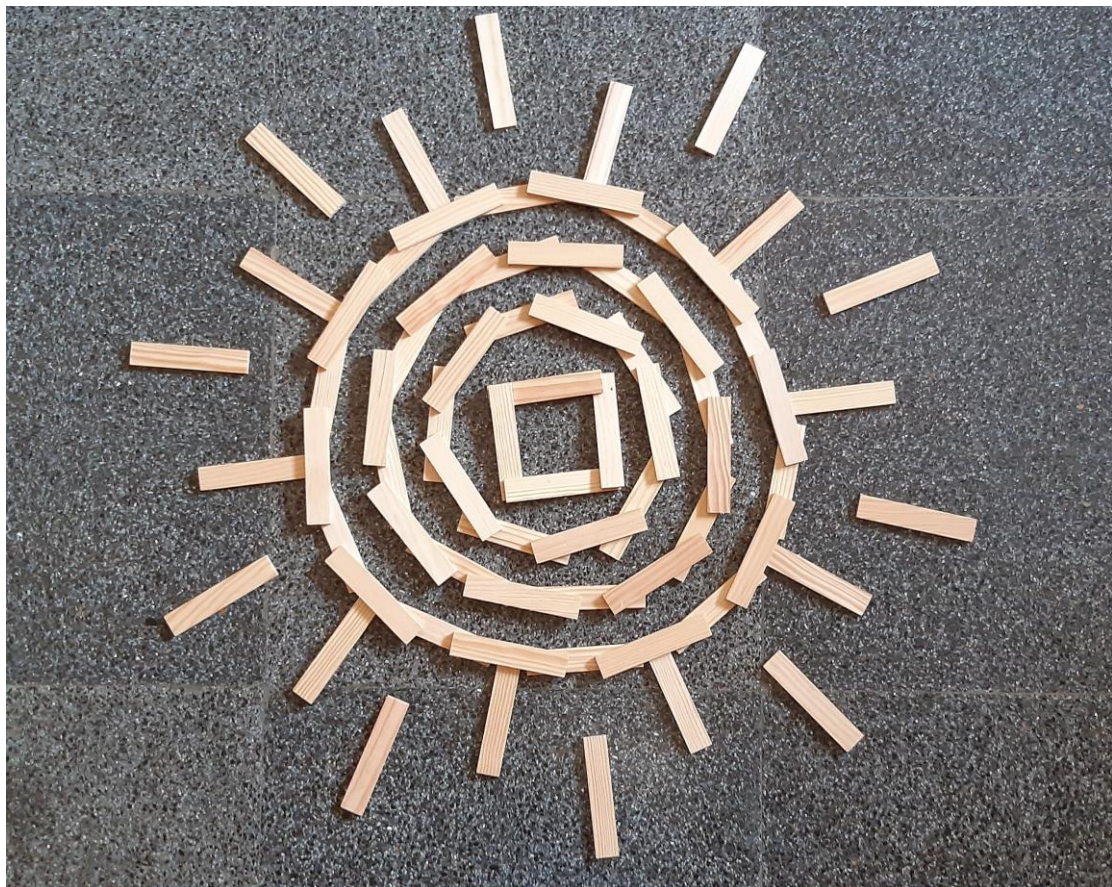

Victoria C.



Marcos N.

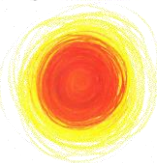

# SOLES OBJETOS



Gerard O.



Lis O.

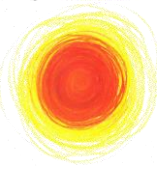

# SOLES OBJETOS

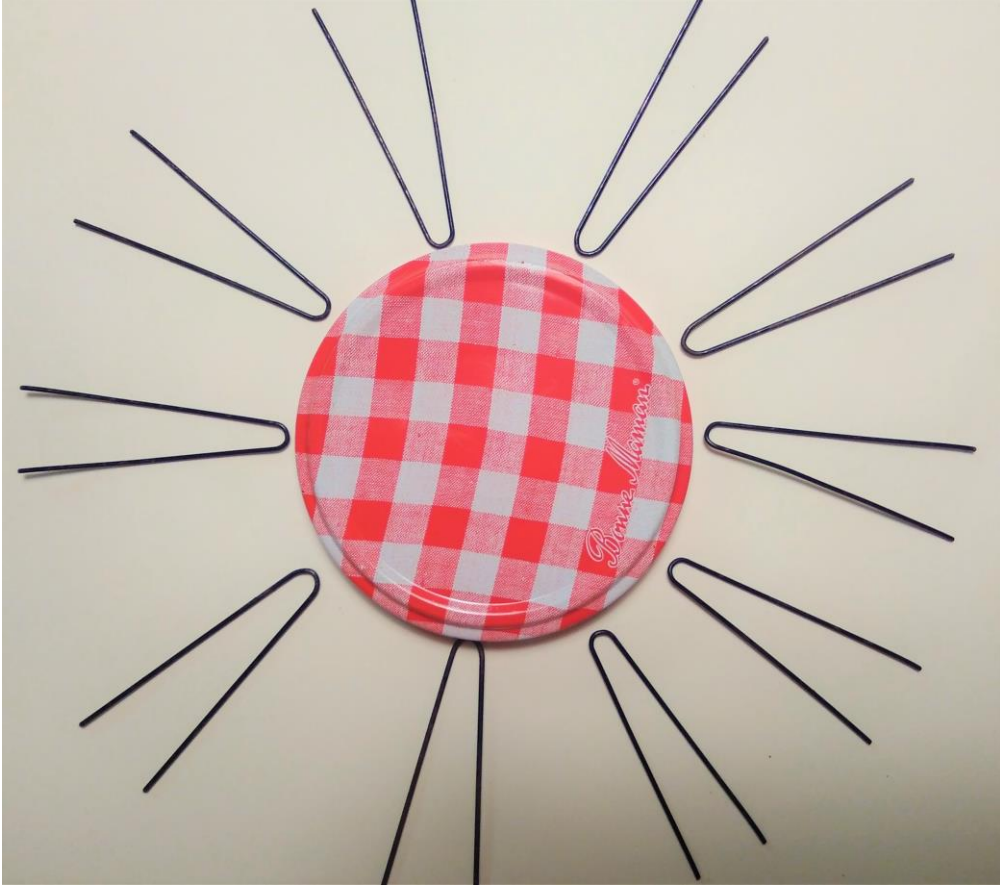

Carmen M. R.

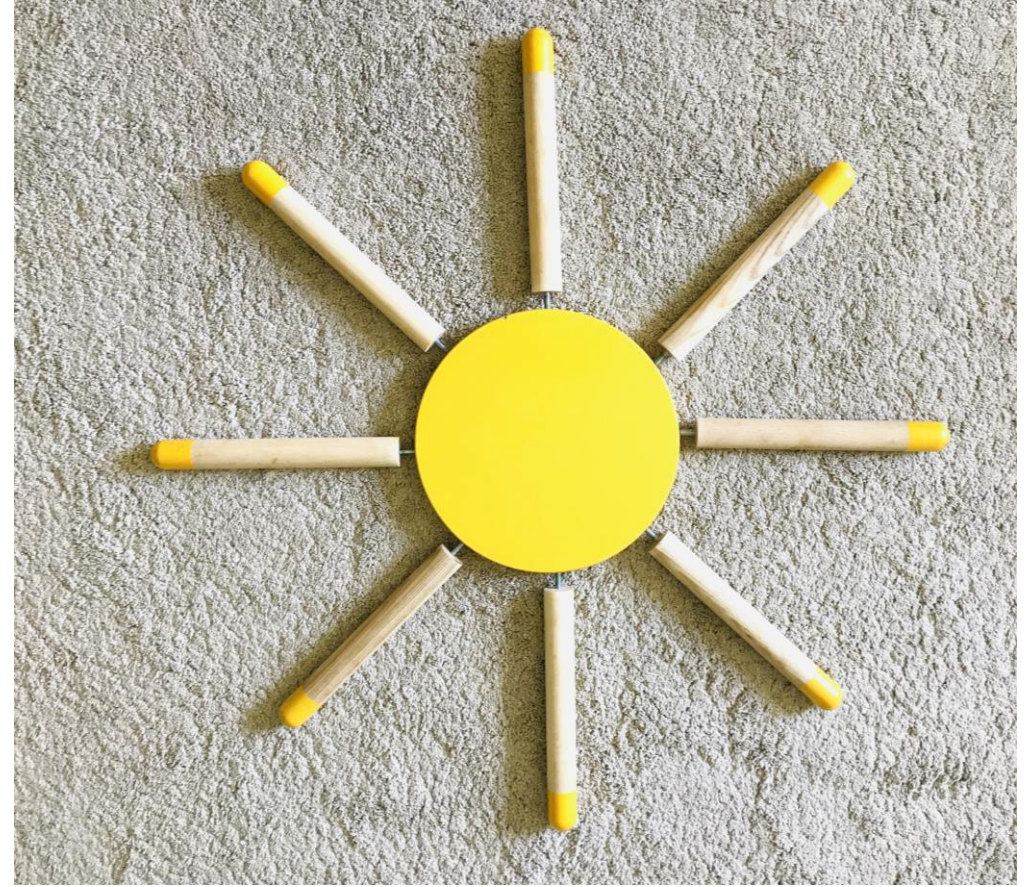

Bruno M.

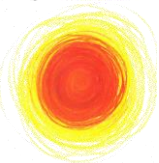

# SOLES OBJETOS

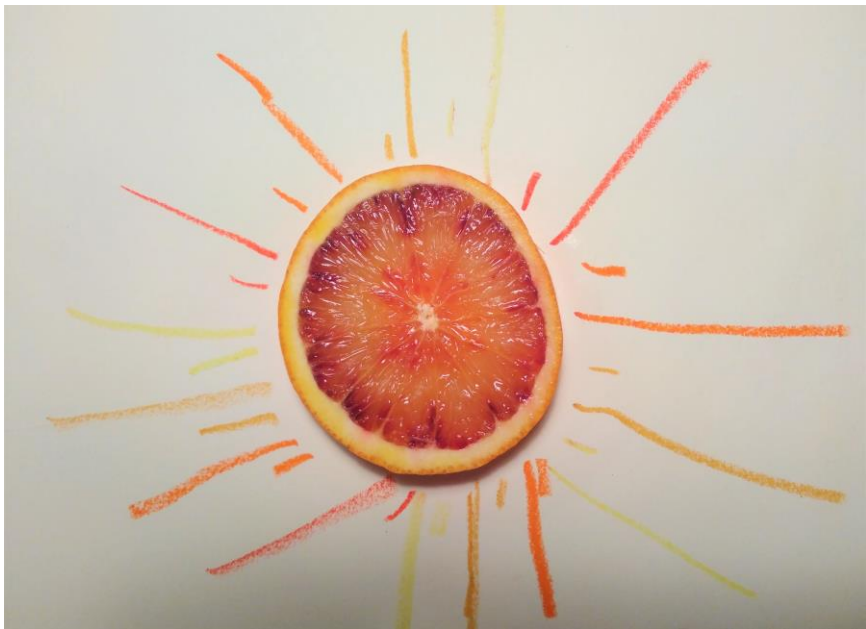

Carmen M. R.



Lis O.



Lucía J.

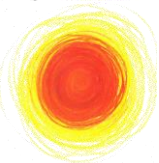

# SOLES OBJETOS



Diego C.



Léon Q.



Rafael S.